

**DiMarzio, Inc.**

1388 Richmond Terrace, PO Box 100387, Staten Island, NY 10310, Tel(718)981-9286, Fax(718)720-5296

## 2 HUM., 4 PUSH/PULL WIRING (DiMarzio color code)

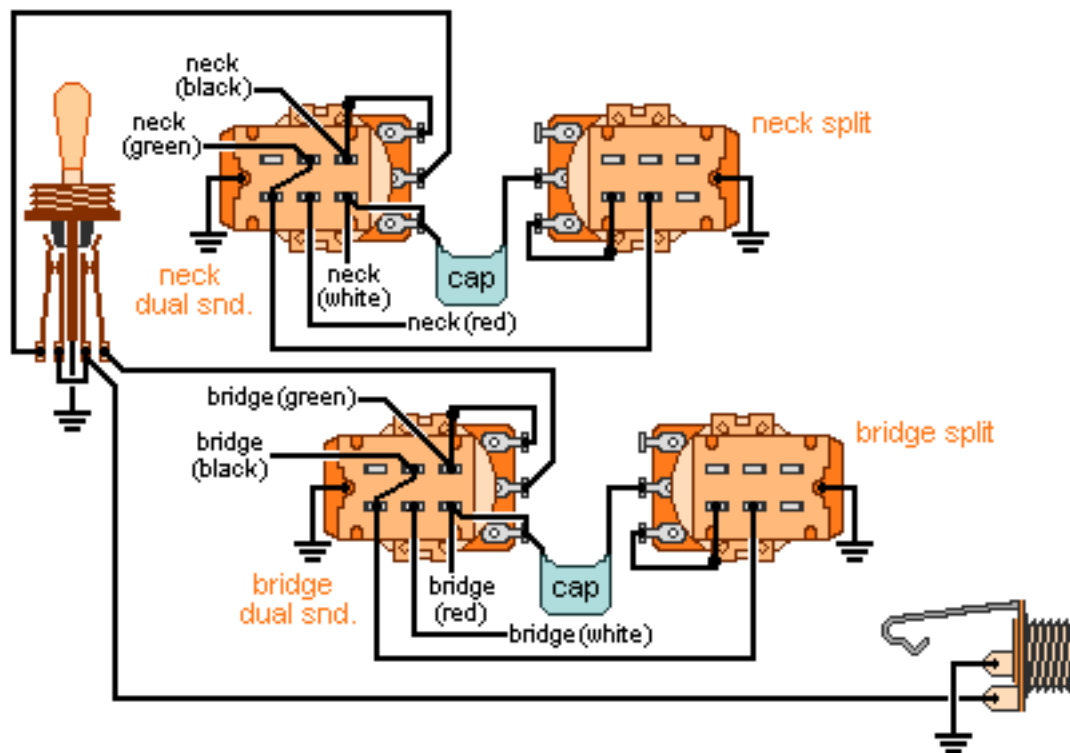

**Note: Tailpiece should be connected to common ground.  
All grounds  $\perp$  must be connected.**

Copyright (C) 2003 DiMarzio, Inc. All rights reserved