

PICKUP CONFIGURATION

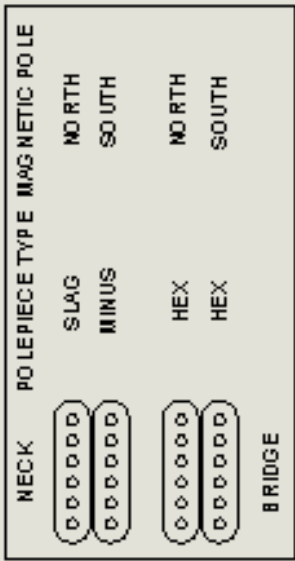

COIL SELECTING CONFIGURATION

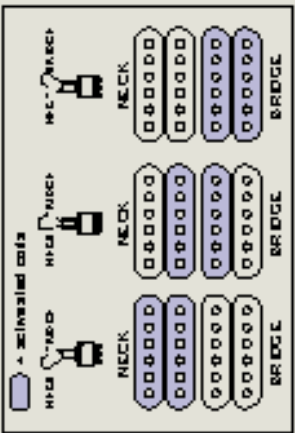

To Bridge GROUND

BRIDGE MIDDLE NECK

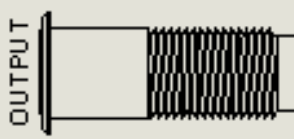
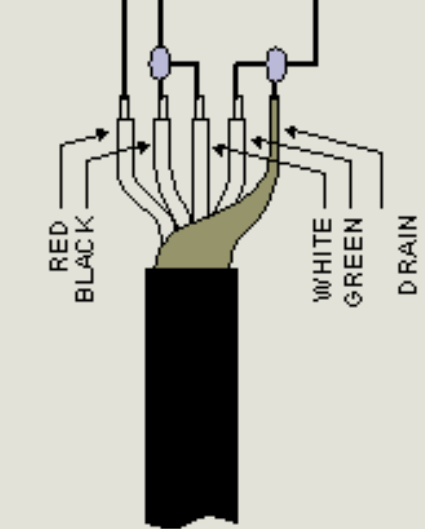
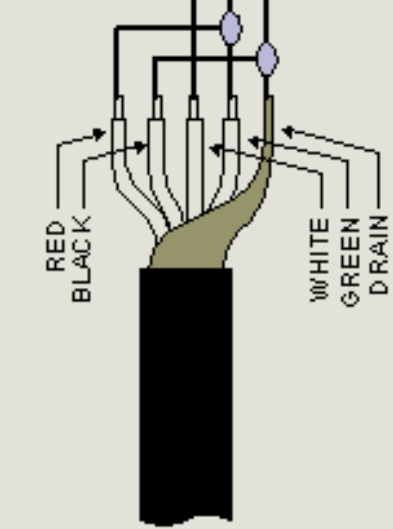
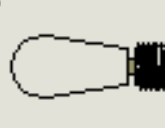
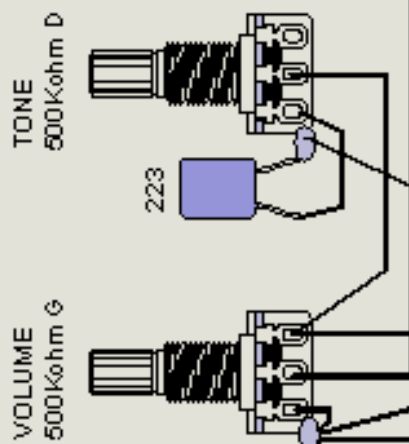

MODEL NUMBER	MODEL NAME	APPROVED BY	CHECKED BY	DRAWING BY	SCALE
SP3/D	JPM100B, JPM100P3			A. M.	
HOSHINO GAKKI CO., LTD. No. 22, 3-CHOME, SHUHO-KU-CHO, HIGASHI-KU, NAGOYA, JAPAN			DRAWING NUMBER	DATE	SIZE
			W97017	'97/01/30	A4